

General Description

These N-Channel enhancement mode power field effect transistors are using trench DMOS technology. This advanced technology has been especially tailored to minimize on-state resistance, provide superior switching performance, and withstand high energy pulse in the avalanche and commutation mode. These devices are well suited for high efficiency fast switching applications.

BVDSS	RDSON	ID
20V	3.5mΩ	80A

Features

- 20V,80A, $R_{DS(ON)} = 3.5m\Omega @ V_{GS} = 10V$
- Improved dv/dt capability
- Fast switching
- 100% EAS Guaranteed
- Green Device Available

PPAK3X3 Pin Configuration

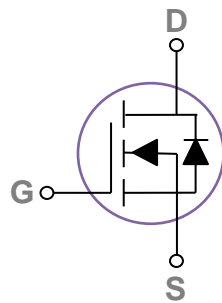
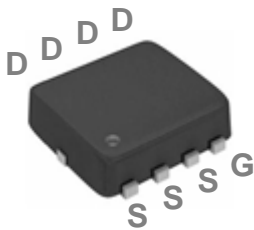

Applications

- MB / VGA / Vcore
- POL Applications
- SMPS 2nd SR

Absolute Maximum Ratings $T_c=25^\circ\text{C}$ unless otherwise noted

Symbol	Parameter	Rating	Units
V_{DS}	Drain-Source Voltage	20	V
V_{GS}	Gate-Source Voltage	± 12	V
I_D	Drain Current – Continuous (Chip Limitation, $T_c=25^\circ\text{C}$)	80	A
	Drain Current – Continuous (Chip Limitation, $T_c=100^\circ\text{C}$)	51	A
I_{DM}	Drain Current – Pulsed ¹	320	A
P_D	Power Dissipation ($T_c=25^\circ\text{C}$)	66	W
	Power Dissipation – Derate above 25°C	0.53	W/ $^\circ\text{C}$
T_{STG}	Storage Temperature Range	-55 to 150	$^\circ\text{C}$
T_J	Operating Junction Temperature Range	-55 to 150	$^\circ\text{C}$

Thermal Characteristics

Symbol	Parameter	Typ.	Max.	Unit
$R_{\theta JA}$	Thermal Resistance Junction to ambient	---	62	$^\circ\text{C/W}$
$R_{\theta JC}$	Thermal Resistance Junction to Case	---	2	$^\circ\text{C/W}$

Electrical Characteristics (T_J=25 °C, unless otherwise noted)
Static State Characteristics

Symbol	Parameter	Conditions	Min.	Typ.	Max.	Unit
BV _{DSS}	Drain-Source Breakdown Voltage	V _{GS} =0V, I _D =250uA	20	---	---	V
I _{DSS}	Drain-Source Leakage Current	V _{DS} =20V, V _{GS} =0V, T _J =25°C	---	---	1	uA
		V _{DS} =16V, V _{GS} =0V, T _J =125°C	---	---	10	uA
I _{GSS}	Gate-Source Leakage Current	V _{GS} =±12V, V _{DS} =0V	---	---	±100	nA
R _{DS(ON)}	Static Drain-Source On-Resistance ²	V _{GS} =4.5V, I _D =15A	2	2.8	3.5	mΩ
		V _{GS} =2.5V, I _D =10A	2.8	3.5	4.5	mΩ
		V _{GS} =1.8V, I _D =6A	4	5	7	mΩ
V _{GS(th)}	Gate Threshold Voltage	V _{GS} =V _{DS} , I _D =250uA	0.3	0.65	1	V
g _{fs}	Forward Transconductance	V _{DS} =5V, I _D =5A	---	35	---	S

Dynamic Characteristics

Q _g	Total Gate Charge	V _{DS} =10V, V _{GS} =4.5V, I _D =5A	---	52	100	nC
Q _{gs}	Gate-Source Charge		---	6.6	12	
Q _{gd}	Gate-Drain Charge		---	13.8	28	
T _{d(on)}	Turn-On Delay Time	V _{DD} =10V, V _{GS} =4.5V, R _G =3.3Ω I _D =1A	---	20.2	40	ns
T _r	Rise Time		---	31.2	60	
T _{d(off)}	Turn-Off Delay Time		---	68.5	120	
T _f	Fall Time		---	21.2	42	
C _{iss}	Input Capacitance	V _{DS} =10V, V _{GS} =0V, F=1MHz	---	3870	5500	pF
C _{oss}	Output Capacitance		---	580	850	
C _{rss}	Reverse Transfer Capacitance		---	340	600	
R _g	Gate resistance	V _{GS} =0V, V _{DS} =0V, F=1MHz	---	1.3	2.6	Ω

Drain-Source Diode Characteristics

Symbol	Parameter	Conditions	Min.	Typ.	Max.	Unit
I _S	Continuous Source Current	V _G =V _D =0V, Force Current	---	---	80	A
I _{SM}	Pulsed Source Current ²		---	---	160	A
V _{SD}	Diode Forward Voltage ²	V _{GS} =0V, I _S =1A, T _J =25°C	---	---	1	V
t _{rr}	Reverse Recovery Time	V _{GS} =0V, I _S =1A, di/dt=100A/μs T _J =25°C	---	---	---	ns
Q _{rr}	Reverse Recovery Charge		---	---	---	nC

Note :

1. Repetitive Rating : Pulsed width limited by maximum junction temperature.
2. The data tested by pulsed , pulse width ≤ 300us , duty cycle ≤ 2%.
3. Essentially independent of operating temperature.

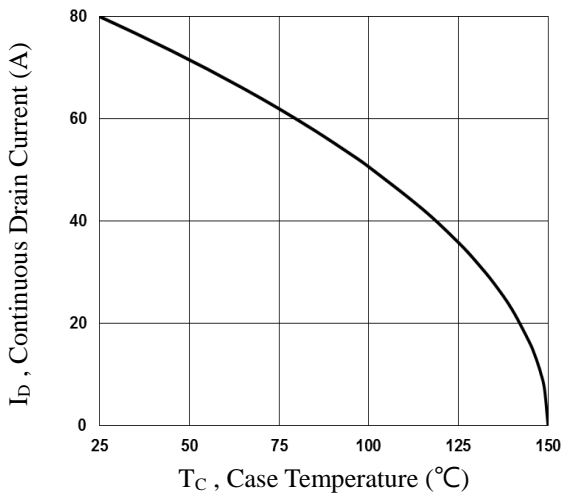

Fig.1 Continuous Drain Current vs. T_c

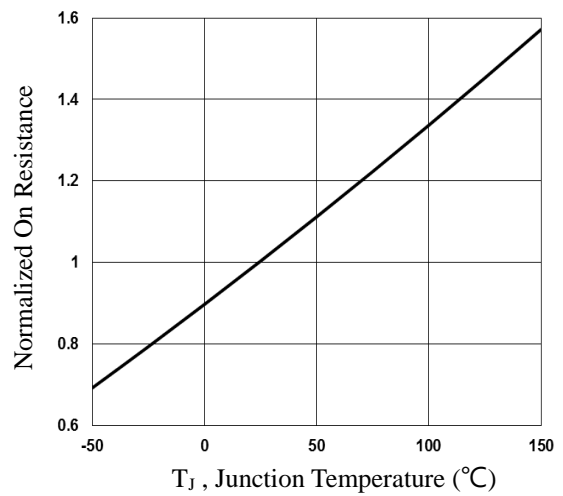

Fig.2 Normalized R_{DSon} vs. T_j

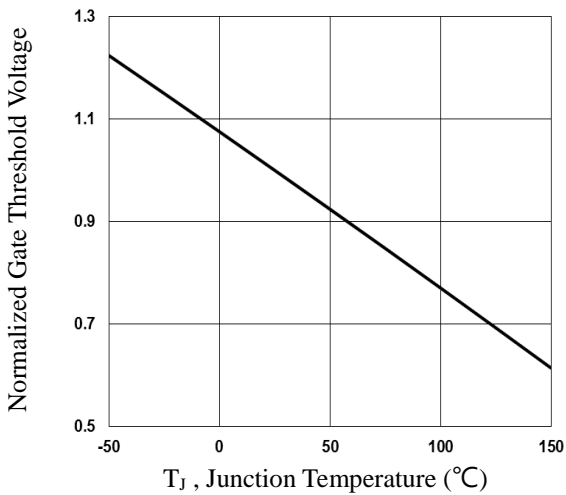

Fig.3 Normalized V_{th} vs. T_j

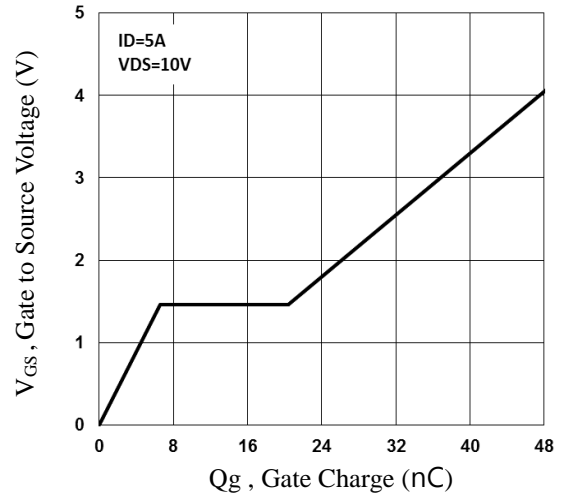

Fig.4 Gate Charge Waveform

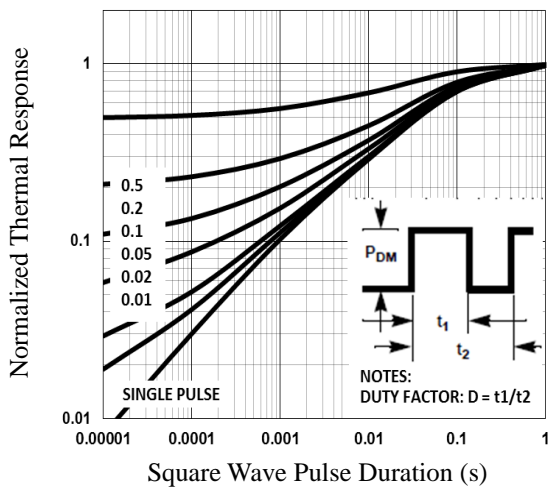

Fig.5 Normalized Transient Impedance

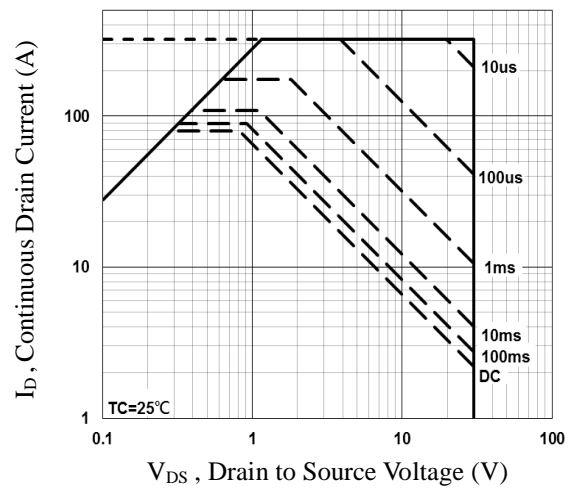

Fig.6 Maximum Safe Operation Area

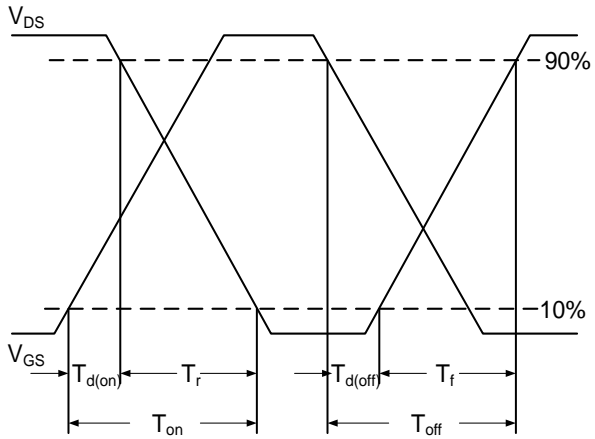

Fig.7 Switching Time Waveform

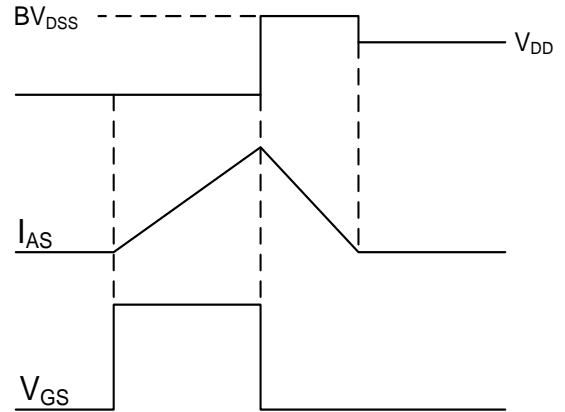
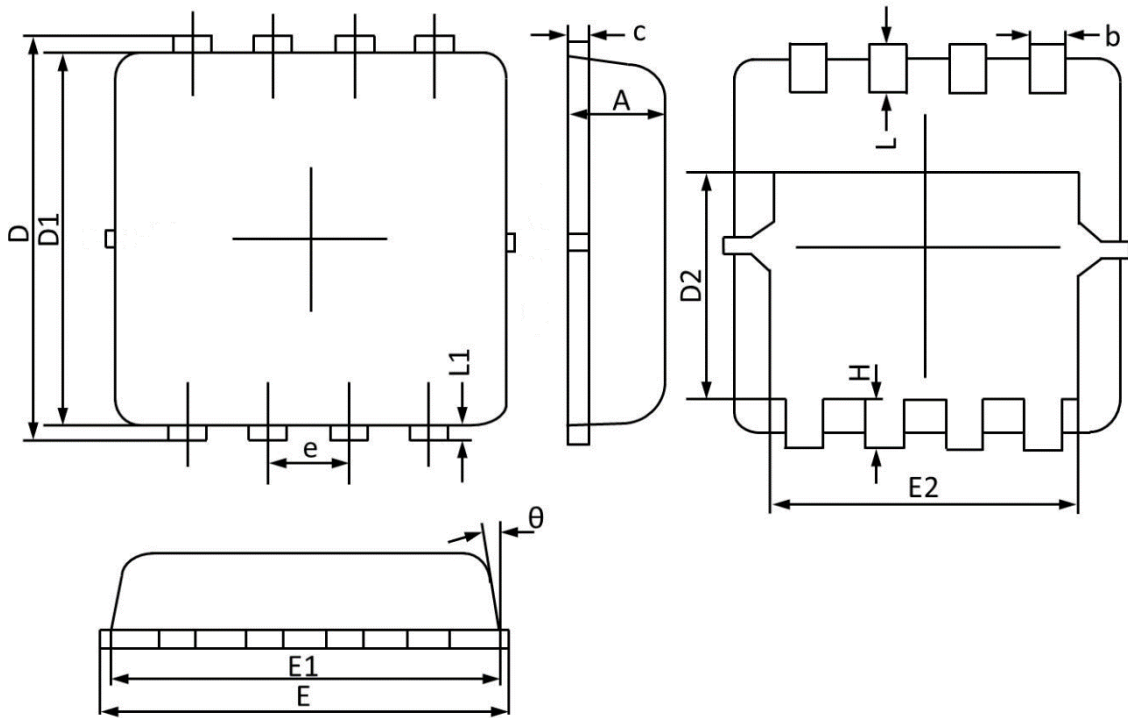

Fig.8 EAS Waveform

PPAK3x3 PACKAGE INFORMATION



Symbol	Dimensions In Millimeters		Dimensions In Inches	
	MAX	MIN	MAX	MIN
A	0.900	0.700	0.035	0.028
b	0.350	0.250	0.014	0.010
c	0.250	0.100	0.010	0.004
D	3.500	3.050	0.138	0.120
D1	3.200	2.900	0.126	0.114
D2	1.950	1.350	0.077	0.053
E	3.400	3.000	0.134	0.118
E1	3.300	2.900	0.130	0.114
E2	2.600	2.350	0.102	0.093
e	0.65BSC		0.026BSC	
H	0.750	0.300	0.030	0.012
L	0.600	0.300	0.024	0.012
L1	0.200	0.060	0.008	0.002
θ	14°	6°	14°	6°

PPAK3X3 RECOMMENDED LAND PATTERN

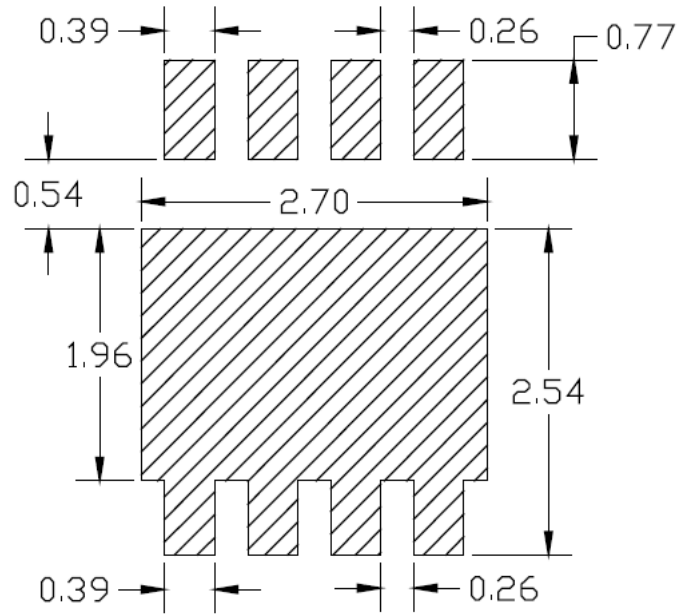

unit : mm