

### General Description

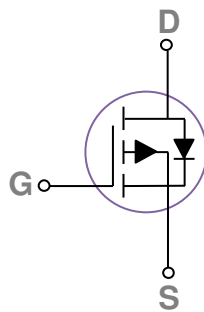
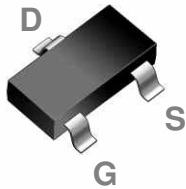
These P-Channel enhancement mode power field effect transistors are using trench DMOS technology. This advanced technology has been especially tailored to minimize on-state resistance, provide superior switching performance, and withstand high energy pulse in the avalanche and commutation mode. These devices are well suited for high efficiency fast switching applications.

BVDSS	RDSON	ID
-30V	90mΩ	-1.4A

### Features

- -30V, -1.4A,  $R_{DS(ON)} = 90m\Omega @ V_{GS} = -10V$
- Fast switching
- Green Device Available
- Suit for -4.5V Gate Drive Applications

### SOT323 Pin Configuration



### Applications

- Notebook
- Load Switch
- Battery Protection
- Hand-held Instruments

### Absolute Maximum Ratings $T_c=25^\circ\text{C}$ unless otherwise noted

Symbol	Parameter	Rating	Units
$V_{DS}$	Drain-Source Voltage	-30	V
$V_{GS}$	Gate-Source Voltage	$\pm 20$	V
$I_D$	Drain Current – Continuous ( $T_A=25^\circ\text{C}$ )	-1.4	A
	Drain Current – Continuous ( $T_A=70^\circ\text{C}$ )	-1.1	A
$I_{DM}$	Drain Current – Pulsed <sup>1</sup>	5.6	A
$P_D$	Power Dissipation ( $T_A=25^\circ\text{C}$ )	0.278	W
	Power Dissipation – Derate above $25^\circ\text{C}$	0.002	W/ $^\circ\text{C}$
$T_{STG}$	Storage Temperature Range	-55 to 150	$^\circ\text{C}$
$T_J$	Operating Junction Temperature Range	-55 to 150	$^\circ\text{C}$

### Thermal Characteristics

Symbol	Parameter	Typ.	Max.	Unit
$R_{\theta JA}$	Thermal Resistance Junction to ambient	---	450	$^\circ\text{C/W}$

**Electrical Characteristics (T<sub>J</sub>=25 °C, unless otherwise noted)**
**Off Characteristics**

Symbol	Parameter	Conditions	Min.	Typ.	Max.	Unit
BV <sub>DSS</sub>	Drain-Source Breakdown Voltage	V <sub>GS</sub> =0V , I <sub>D</sub> =-250uA	-30	---	---	V
ΔBV <sub>DSS</sub> /ΔT <sub>J</sub>	BV <sub>DSS</sub> Temperature Coefficient	Reference to 25°C , I <sub>D</sub> =-1mA	---	-0.02	---	V/°C
I <sub>DSS</sub>	Drain-Source Leakage Current	V <sub>DS</sub> =-27V , V <sub>GS</sub> =0V , T <sub>J</sub> =25°C	---	---	-1	uA
		V <sub>DS</sub> =-24V , V <sub>GS</sub> =0V , T <sub>J</sub> =125°C	---	---	-10	uA
I <sub>GSS</sub>	Gate-Source Leakage Current	V <sub>GS</sub> =±20V , V <sub>DS</sub> =0V	---	---	±100	nA

**On Characteristics**

R <sub>DS(ON)</sub>	Static Drain-Source On-Resistance	V <sub>GS</sub> =-10V , I <sub>D</sub> =-1A	---	75	90	mΩ
		V <sub>GS</sub> =-4.5V , I <sub>D</sub> =-0.8A	---	110	140	mΩ
V <sub>GS(th)</sub>	Gate Threshold Voltage	V <sub>GS</sub> =V <sub>DS</sub> , I <sub>D</sub> =-250uA	-1.2	-1.6	-2.2	V
ΔV <sub>GS(th)</sub>	V <sub>GS(th)</sub> Temperature Coefficient		---	-2.8	---	mV/°C
g <sub>fs</sub>	Forward Transconductance	V <sub>DS</sub> =-10V , I <sub>D</sub> =-1A	---	3	---	S

**Dynamic and switching Characteristics**

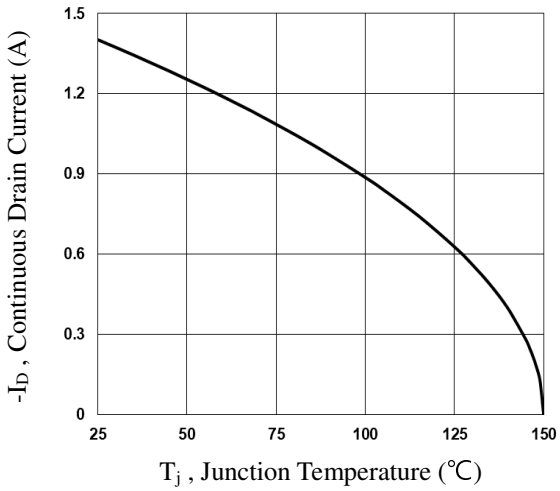
Q <sub>g</sub>	Total Gate Charge <sup>2, 3</sup>	V <sub>DS</sub> =-24V , V <sub>GS</sub> =-4.5V , I <sub>D</sub> =-1A	---	2.5	5	nC
Q <sub>gs</sub>	Gate-Source Charge <sup>2, 3</sup>		---	0.1	0.3	
Q <sub>gd</sub>	Gate-Drain Charge <sup>2, 3</sup>		---	1.8	3.6	
T <sub>d(on)</sub>	Turn-On Delay Time <sup>2, 3</sup>	V <sub>DD</sub> =-15V , V <sub>GS</sub> =-10V , R <sub>G</sub> =6Ω I <sub>D</sub> =-1A	---	6.1	12	ns
T <sub>r</sub>	Rise Time <sup>2, 3</sup>		---	8.7	17	
T <sub>d(off)</sub>	Turn-Off Delay Time <sup>2, 3</sup>		---	33.2	66	
T <sub>f</sub>	Fall Time <sup>2, 3</sup>		---	3.7	7	
C <sub>iss</sub>	Input Capacitance	V <sub>DS</sub> =-15V , V <sub>GS</sub> =0V , F=1MHz	---	226	450	pF
C <sub>oss</sub>	Output Capacitance		---	39	78	
C <sub>rss</sub>	Reverse Transfer Capacitance		---	29	58	

**Drain-Source Diode Characteristics and Maximum Ratings**

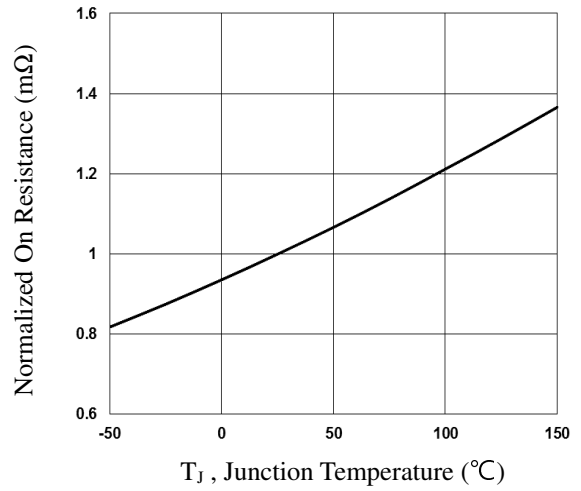
Symbol	Parameter	Conditions	Min.	Typ.	Max.	Unit
I <sub>S</sub>	Continuous Source Current	V <sub>G</sub> =V <sub>D</sub> =0V , Force Current	---	---	-1.4	A
I <sub>SM</sub>	Pulsed Source Current		---	---	-2.8	A
V <sub>SD</sub>	Diode Forward Voltage	V <sub>GS</sub> =0V , I <sub>S</sub> =-1A , T <sub>J</sub> =25°C	---	---	-1	V

Note :

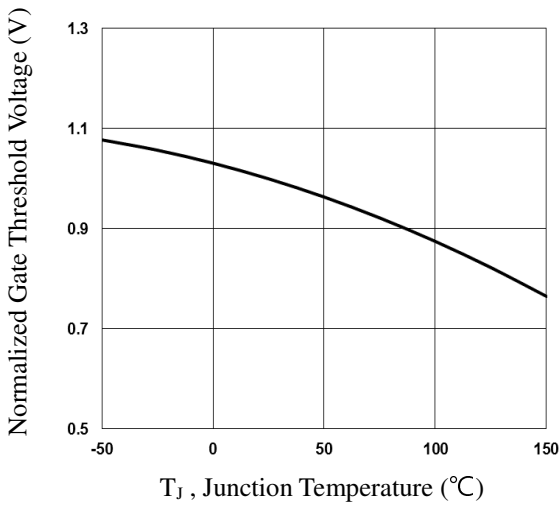
1. Repetitive Rating : Pulsed width limited by maximum junction temperature.
2. The data tested by pulsed , pulse width ≤ 300us , duty cycle ≤ 2%.
3. Essentially independent of operating temperature.



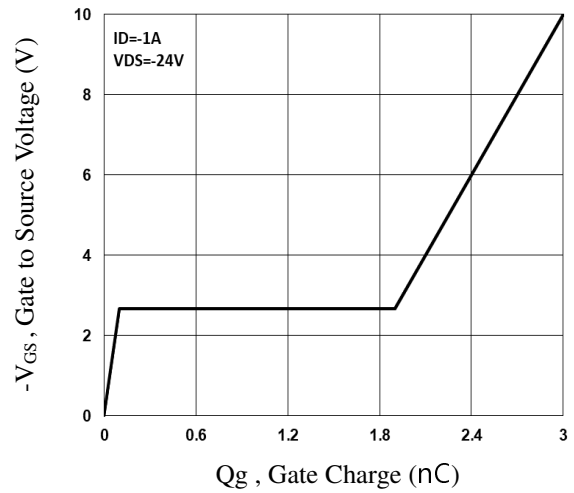
**Fig.1 Continuous Drain Current vs.  $T_j$**



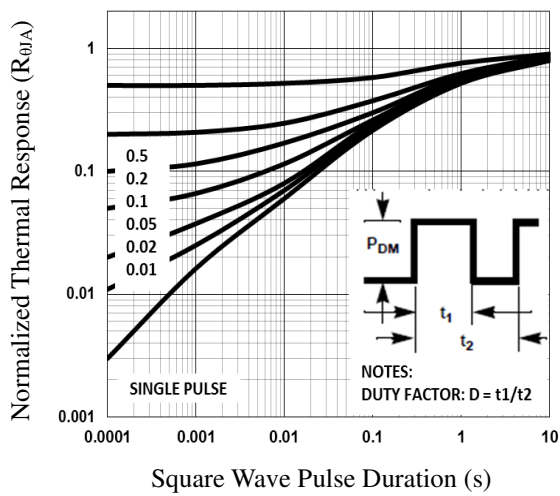
**Fig.2 Normalized  $R_{DS(on)}$  vs.  $T_j$**



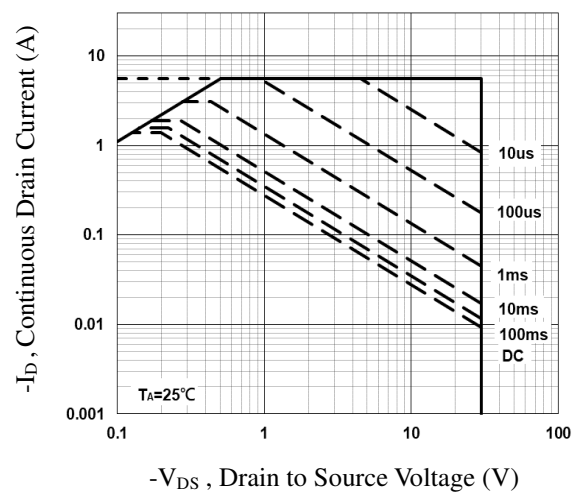
**Fig.3 Normalized  $V_{th}$  vs.  $T_j$**



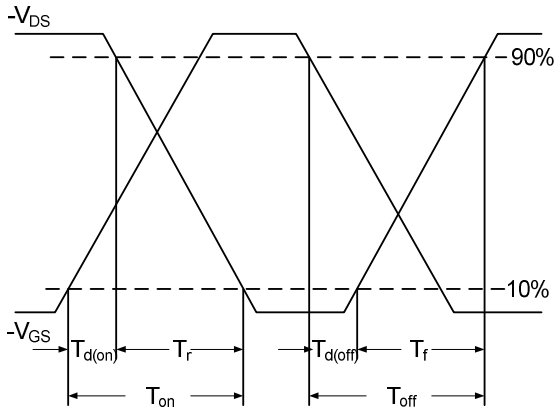
**Fig.4 Gate Charge Waveform**



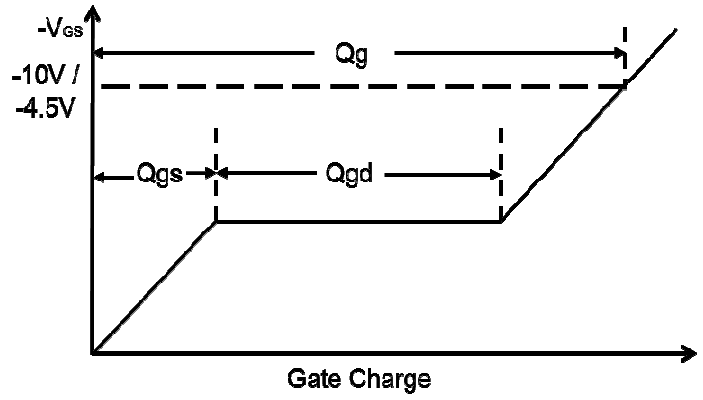
**Fig.5 Normalized Transient Impedance**



**Fig.6 Maximum Safe Operation Area**

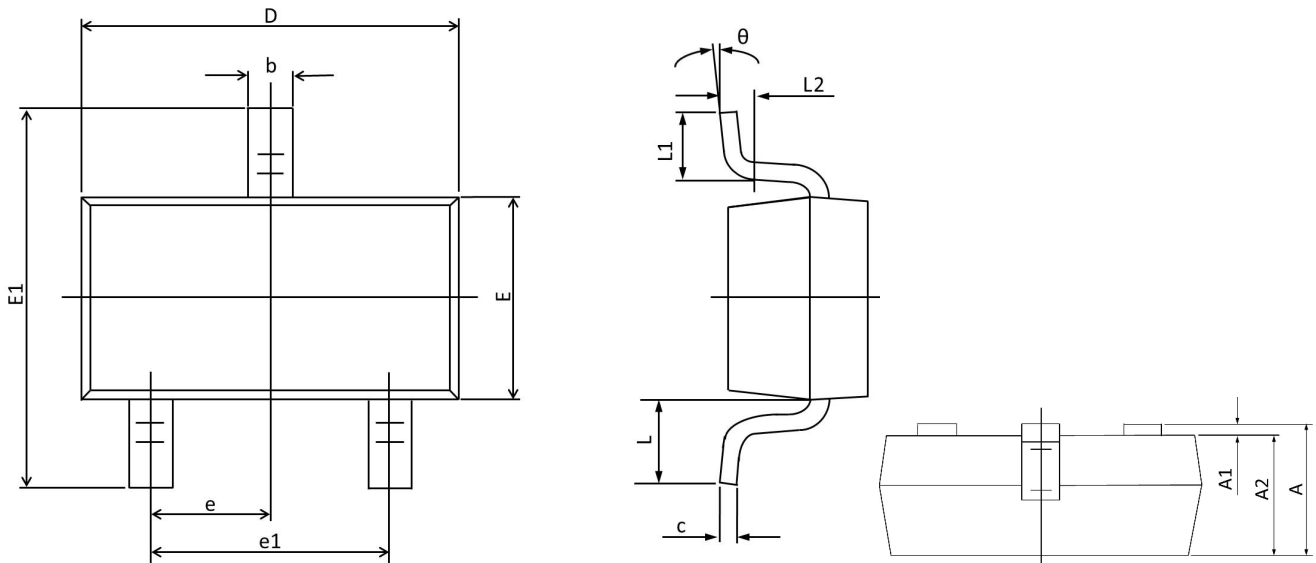


**Fig.7 Switching Time Waveform**



**Fig.8 Gate Charge Waveform**

## SOT323 PACKAGE INFORMATION



Symbol	Dimensions In Millimeters		Dimensions In Inches	
	MAX	MIN	MAX	MIN
A	1.100	0.800	0.043	0.031
A1	0.100	0.000	0.004	0.000
A2	1.000	0.800	0.039	0.031
b	0.400	0.200	0.016	0.008
c	0.250	0.080	0.010	0.003
D	2.200	1.800	0.087	0.071
E	1.350	1.150	0.053	0.045
E1	2.450	1.800	0.096	0.071
e	0.65BSC		0.026BSC	
e1	1.400	1.200	0.055	0.047
L	0.525REF.		0.021REF.	
L1	0.460	0.150	0.018	0.006
L2	0.200	0.000	0.008	0.000
$\theta$	8°	0°	8°	0°