

## General Description

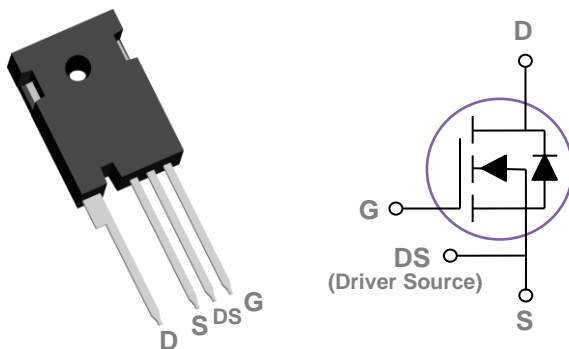
These N-Channel enhancement mode power field effect transistors are using silicon carbide technology. This advanced technology has been especially tailored to minimize on-state resistance, provide superior switching performance, and withstand high energy pulse in the avalanche and commutation mode. These devices are well suited for high efficiency fast switching applications.

|       |                   |     |
|-------|-------------------|-----|
| BVDSS | $R_{DS(ON)(typ)}$ | ID  |
| 1200V | 40mΩ              | 45A |

## Features

- 1200V,45A,  $R_{DS(ON)(typ)} = 40m\Omega @ V_{GS} = 18V$
- Improved  $dv/dt$  capability
- Fast switching
- Green Device Available

## TO247-4L Pin Configuration



## Applications

- SMPS
- Solar Inverters
- Renewable energy
- EV battery chargers

## Absolute Maximum Ratings $T_c=25^\circ C$ unless otherwise noted

| Symbol    | Parameter  | Rating     | Units |
|-----------|--|------------|-------|
| $V_{DS}$  | Drain-Source Voltage                             | 1200       | V     |
| $V_{GS}$  | Gate-Source Voltage                              | +22/-10    | V     |
| $I_D$     | Drain Current – Continuous ( $T_c=25^\circ C$ )  | 45         | A     |
|           | Drain Current – Continuous ( $T_c=100^\circ C$ ) | 32         | A     |
| $I_{DM}$  | Drain Current – Pulsed <sup>1</sup>              | 112        | A     |
| $P_D$     | Power Dissipation ( $T_c=25^\circ C$ )           | 250        | W     |
|           | Power Dissipation – Derate above 25°C            | 1.67       | W/°C  |
| $T_{STG}$ | Storage Temperature Range                        | -55 to 175 | °C    |
| $T_J$     | Operating Junction Temperature Range             | -55 to 175 | °C    |

## Thermal Characteristics

| Symbol          | Parameter                           | Typ. | Max. | Unit |
|-----------------|-------------------------------------|------|------|------|
| $R_{\theta JC}$ | Thermal Resistance Junction to Case | 0.6  | ---  | °C/W |

**Electrical Characteristics (T<sub>J</sub>=25 °C, unless otherwise noted)**
**Off Characteristics**

| Symbol            | Parameter                      | Conditions  | Min. | Typ. | Max. | Unit |
|-------------------|--------------------------------|---|------|------|------|------|
| BV <sub>DSS</sub> | Drain-Source Breakdown Voltage | V <sub>GS</sub> =0V, I <sub>D</sub> =100μA                        | 1200 | ---  | ---  | V    |
| I <sub>DSS</sub>  | Drain-Source Leakage Current   | V <sub>DS</sub> =1200V, V <sub>GS</sub> =0V, T <sub>J</sub> =25°C | ---  | ---  | 10   | μA   |
| I <sub>GSS</sub>  | Gate-Source Leakage Current    | V <sub>GS</sub> =22V, V <sub>DS</sub> =0V                         | ---  | ---  | 100  | nA   |

**On Characteristics**

|                     |                                   |   |     |     |     |    |
|---------------------|-----------------------------------|---|-----|-----|-----|----|
| R <sub>DS(ON)</sub> | Static Drain-Source On-Resistance | V <sub>GS</sub> =18V, I <sub>D</sub> =20A               | --- | 40  | 52  | mΩ |
| R <sub>DS(ON)</sub> | Static Drain-Source On-Resistance | V <sub>GS</sub> =15V, I <sub>D</sub> =20A               | --- | 46  | --- | mΩ |
| V <sub>GS(th)</sub> | Gate Threshold Voltage            | V <sub>GS</sub> =V <sub>DS</sub> , I <sub>D</sub> =10mA | 2.0 | 2.8 | 4.0 | V  |

**Dynamic and switching Characteristics**

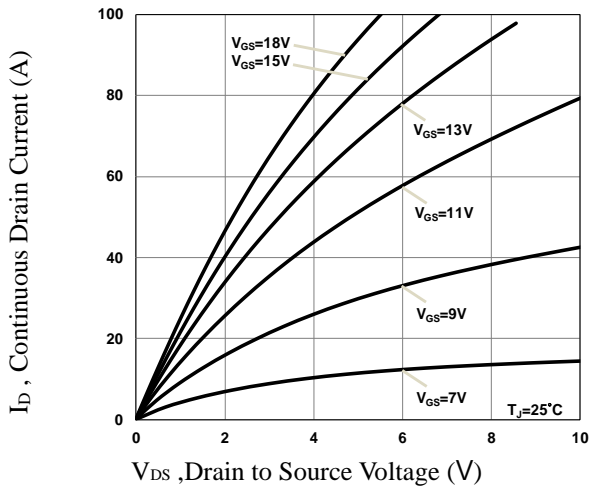
|                     |                              |  |     |      |     |    |
|---------------------|------------------------------|--|-----|------|-----|----|
| Q <sub>g</sub>      | Total Gate Charge            | V <sub>DS</sub> =800V, V <sub>GS</sub> =-5/18V, I <sub>DS</sub> =30A                     | --- | 90   | --- | nC |
| Q <sub>gs</sub>     | Gate-Source Charge           |  | --- | 15   | --- |    |
| Q <sub>gd</sub>     | Gate-Drain Charge            |  | --- | 25   | --- |    |
| T <sub>d(on)</sub>  | Turn-On Delay Time           | V <sub>DD</sub> =800V, V <sub>GS</sub> =-5/18V, R <sub>G</sub> =6Ω, I <sub>DS</sub> =30A | --- | 10   | --- | ns |
| T <sub>r</sub>      | Rise Time                    |  | --- | 15   | --- |    |
| T <sub>d(off)</sub> | Turn-Off Delay Time          |  | --- | 20   | --- |    |
| T <sub>f</sub>      | Fall Time                    |  | --- | 10   | --- |    |
| C <sub>iss</sub>    | Input Capacitance            | V <sub>DS</sub> =1000V, V <sub>GS</sub> =0V, F=500kHz, V <sub>AC</sub> =25mV             | --- | 1770 | --- | pF |
| C <sub>oss</sub>    | Output Capacitance           |  | --- | 105  | --- |    |
| C <sub>rss</sub>    | Reverse Transfer Capacitance |  | --- | 5    | --- |    |
| R <sub>g</sub>      | Gate resistance              | V <sub>GS</sub> =0V, V <sub>DS</sub> =0V, F=1MHz   | --- | 0.75 | --- | Ω  |

**Drain-Source Diode Characteristics and Maximum Ratings**

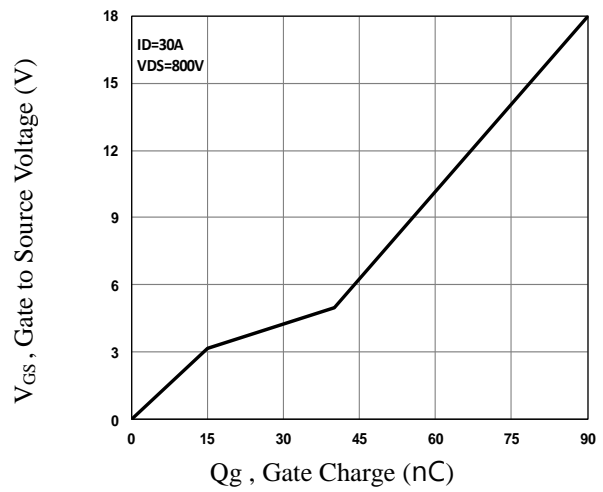
| Symbol          | Parameter                 | Conditions  | Min. | Typ. | Max. | Unit |
|-----------------|---------------------------|---|------|------|------|------|
| I <sub>S</sub>  | Continuous Source Current | V <sub>G</sub> =V <sub>D</sub> =0V, Force Current               | ---  | ---  | 45   | A    |
| V <sub>SD</sub> | Diode Forward Voltage     | V <sub>GS</sub> =-5V, I <sub>S</sub> =20A, T <sub>J</sub> =25°C | ---  | 4.9  | ---  | V    |
| t <sub>rr</sub> | Reverse Recovery Time     | V <sub>R</sub> =400V, I <sub>S</sub> =20A                       | ---  | 50   | ---  | ns   |
| Q <sub>rr</sub> | Reverse Recovery Charge   | di/dt=300A/μs, T <sub>J</sub> =25°C                             | ---  | 110  | ---  | nC   |

Note :

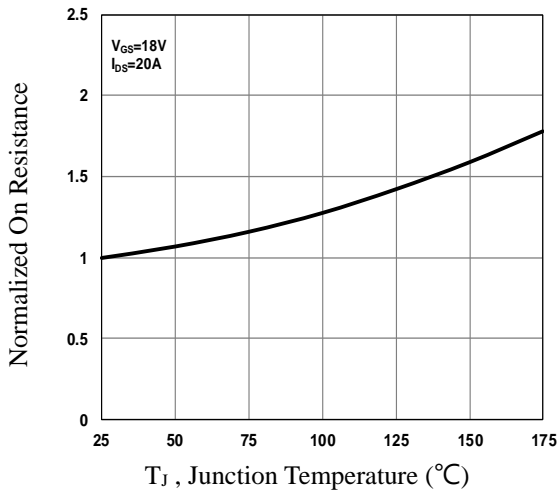
1. Repetitive Rating : Pulsed width limited by maximum junction temperature.
2. The data tested by pulsed, pulse width ≤ 300μs, duty cycle ≤ 2%.



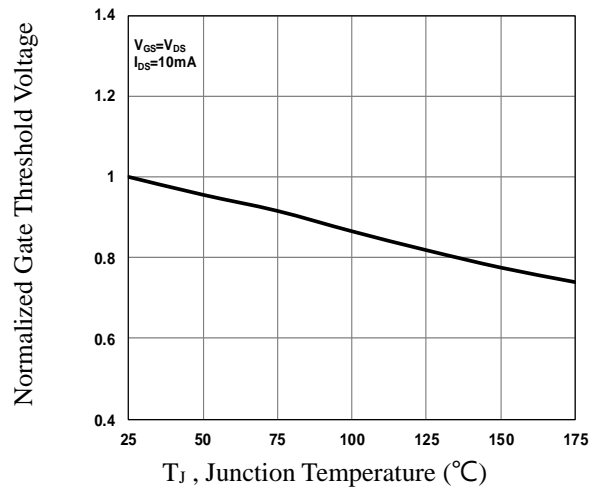
**Fig.1 Typical Output Characteristics**



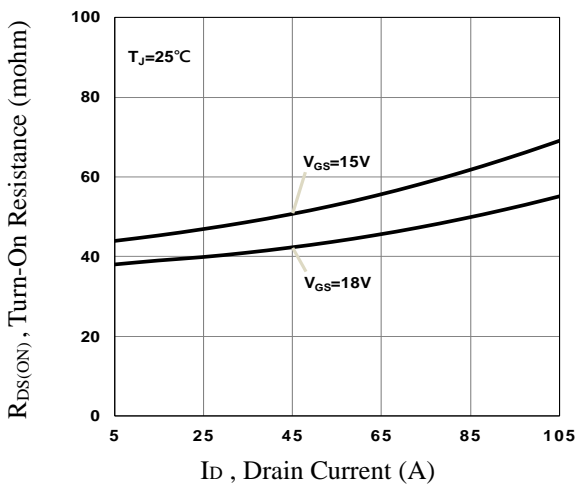
**Fig.2 Gate Charge Characteristics**



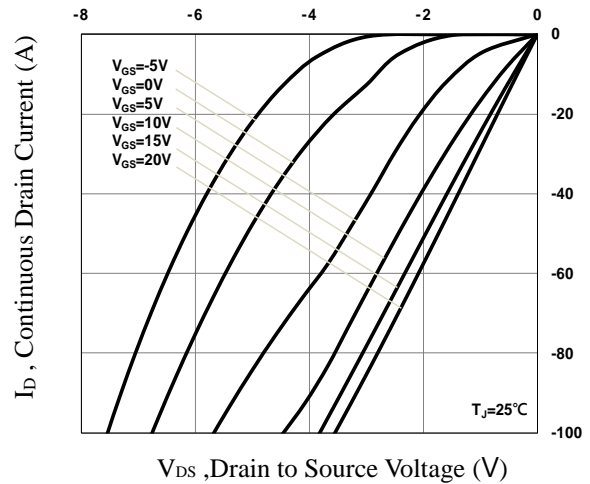
**Fig.3 Normalized  $R_{DS(on)}$  vs.  $T_J$**



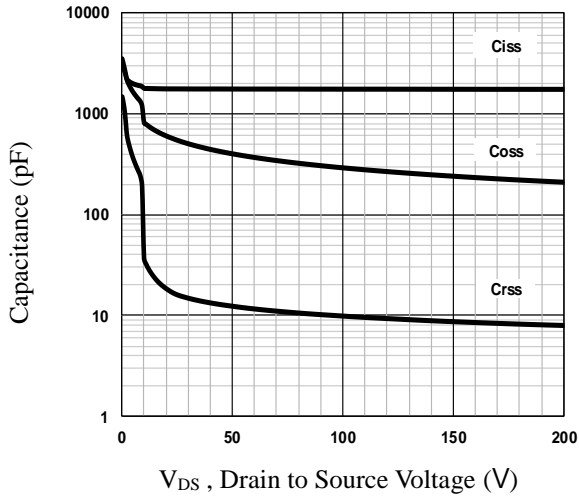
**Fig.4 Normalized  $V_{th}$  vs.  $T_J$**



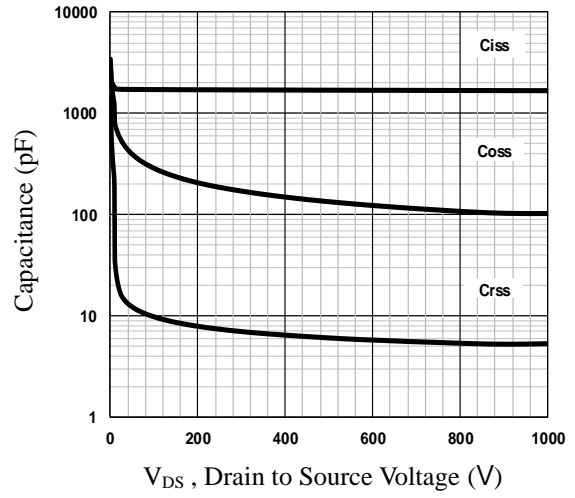
**Fig.5 Turn-On Resistance vs.  $I_D$**



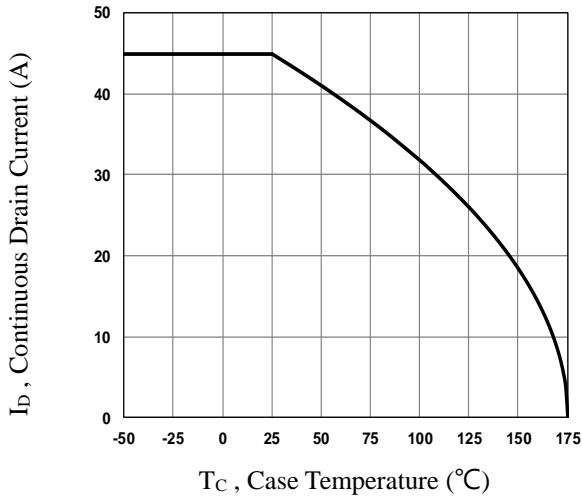
**Fig.6 3rd Quadrant Characteristic**



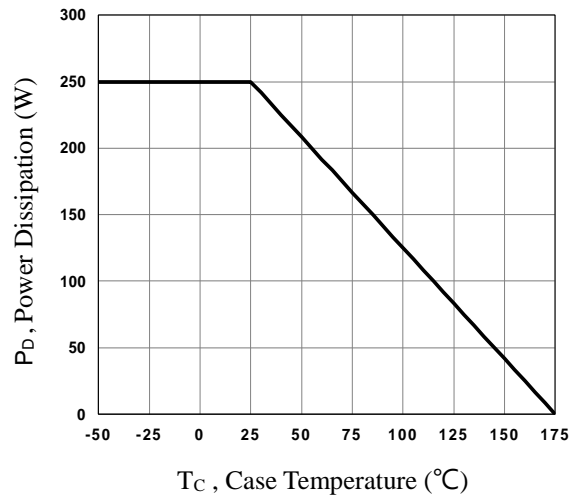
**Fig.7 Capacitance Characteristics**



**Fig.8 Capacitance Characteristics**

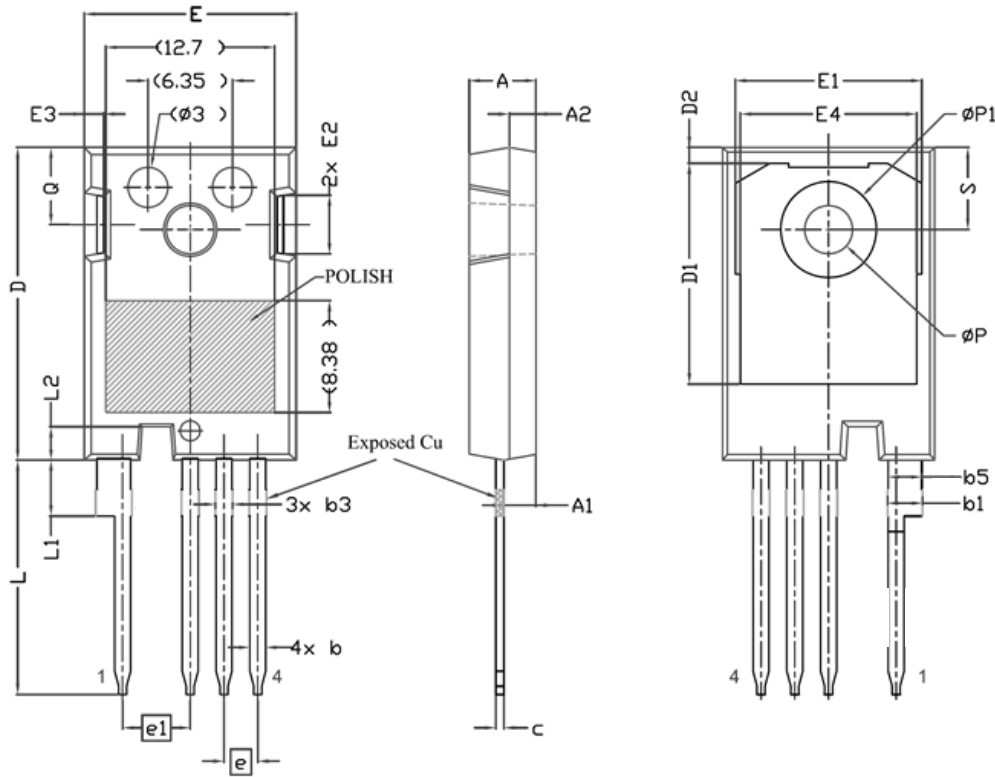


**Fig.9 Continuous Drain Current vs. T<sub>c</sub>**



**Fig.10 Power Dissipation Derating vs. T<sub>c</sub>**

**TO247-4L PACKAGE INFORMATION**



| SYMBOL | mm    |       | SYMBOL    | mm        |       |
|--------|-------|-------|-----------|-----------|-------|
|        | MIN   | MAX   |           | MIN       | MAX   |
| A      | 4.83  | 5.21  | D2        | 0.95      | 1.25  |
| A1     | 2.29  | 2.54  | E         | 15.75     | 16.13 |
| A2     | 1.91  | 2.16  | E1        | 13.10     | 14.15 |
| b'     | 1.07  | 1.28  | E2        | 3.68      | 5.10  |
| b      | 1.07  | 1.33  | E3        | 1.00      | 1.90  |
| b1     | 2.39  | 2.94  | E4        | 12.38     | 13.43 |
| b2     | 2.39  | 2.84  | e         | 2.54 BSC  |       |
| b3     | 1.07  | 1.60  | e1        | 5.08 BSC  |       |
| b4     | 1.07  | 1.50  | L         | 17.31     | 17.82 |
| b5     | 2.39  | 2.69  | L1        | 3.97      | 4.37  |
| b6     | 2.39  | 2.64  | L2        | 2.35      | 2.65  |
| c      | 0.55  | 0.68  | $\phi P$  | 3.51      | 3.65  |
| c1     | 0.55  | 0.65  | $\phi P1$ | 7.19 REF. |       |
| D      | 23.30 | 23.60 | Q         | 5.49      | 6.00  |
| D1     | 16.25 | 17.65 | S         | 6.04      | 6.30  |