

General Description

These N-Channel enhancement mode power field effect transistors are using silicon carbide technology. This advanced technology has been especially tailored to minimize on-state resistance, provide superior switching performance, and withstand high energy pulse in the avalanche and commutation mode. These devices are well suited for high efficiency fast switching applications.

BVDSS	$R_{DS(ON)(typ)}$	ID
1200V	60mΩ	35A

Features

- 1200V,35A, $R_{DS(ON)(typ)} = 60m\Omega @ V_{GS} = 18V$
- Improved dv/dt capability
- Fast switching
- Green Device Available

TO247 Pin Configuration

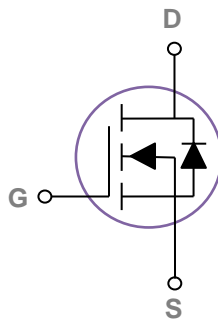
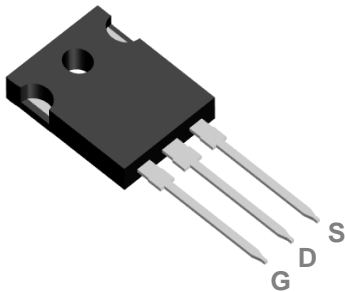

Applications

- SMPS
- Solar Inverters
- Renewable energy
- EV battery chargers

Absolute Maximum Ratings $T_c=25^\circ C$ unless otherwise noted

Symbol	Parameter	Rating	Units
V_{DS}	Drain-Source Voltage	1200	V
V_{GS}	Gate-Source Voltage	+22/-10	V
I_D	Drain Current – Continuous ($T_c=25^\circ C$)	35	A
	Drain Current – Continuous ($T_c=100^\circ C$)	25	A
I_{DM}	Drain Current – Pulsed ¹	70	A
P_D	Power Dissipation ($T_c=25^\circ C$)	200	W
	Power Dissipation – Derate above $25^\circ C$	1.33	W/ $^\circ C$
T_{STG}	Storage Temperature Range	-55 to 175	$^\circ C$
T_J	Operating Junction Temperature Range	-55 to 175	$^\circ C$

Thermal Characteristics

Symbol	Parameter	Typ.	Max.	Unit
$R_{\theta JC}$	Thermal Resistance Junction to Case	0.75	---	$^\circ C/W$

Electrical Characteristics (T_J=25 °C, unless otherwise noted)
Off Characteristics

Symbol	Parameter	Conditions	Min.	Typ.	Max.	Unit
BV _{DSS}	Drain-Source Breakdown Voltage	V _{GS} =0V , I _D =100μA	1200	---	---	V
I _{DSS}	Drain-Source Leakage Current	V _{DS} =1200V , V _{GS} =0V , T _J =25°C	---	---	10	μA
I _{GSS}	Gate-Source Leakage Current	V _{GS} =22V , V _{DS} =0V	---	---	100	nA

On Characteristics

R _{DS(ON)}	Static Drain-Source On-Resistance	V _{GS} =18V , I _D =20A	---	60	78	mΩ
R _{DS(ON)}	Static Drain-Source On-Resistance	V _{GS} =15V , I _D =20A	---	80	---	mΩ
V _{GS(th)}	Gate Threshold Voltage	V _{GS} =V _{DS} , I _D =2mA	1.7	2.3	2.8	V

Dynamic and switching Characteristics

Q _g	Total Gate Charge	V _{DS} =800V , V _{GS} =-5/18V , I _{DS} =20A	---	60	---	nC
Q _{gs}	Gate-Source Charge		---	12.5	---	
Q _{gd}	Gate-Drain Charge		---	16.5	---	
T _{d(on)}	Turn-On Delay Time	V _{DD} =800V , V _{GS} =-5/18V , R _G =6Ω , I _{DS} =20A	---	10	---	ns
T _r	Rise Time		---	25	---	
T _{d(off)}	Turn-Off Delay Time		---	30	---	
T _f	Fall Time		---	10	---	
C _{iss}	Input Capacitance	V _{DS} =1000V , V _{GS} =0V , F=500kHz , V _{AC} =25mV	---	1350	---	pF
C _{oss}	Output Capacitance		---	75	---	
C _{rss}	Reverse Transfer Capacitance		---	3.8	---	
R _g	Gate resistance	V _{GS} =0V , V _{DS} =0V , F=1MHz	---	2.3	---	Ω

Drain-Source Diode Characteristics and Maximum Ratings

Symbol	Parameter	Conditions	Min.	Typ.	Max.	Unit
I _S	Continuous Source Current	V _G =V _D =0V , Force Current	---	---	35	A
V _{SD}	Diode Forward Voltage	V _{GS} =-5V , I _S =20A , T _J =25°C	---	4.1	---	V
t _{rr}	Reverse Recovery Time	V _R =400V , I _S =20A	---	45	---	ns
Q _{rr}	Reverse Recovery Charge	di/dt=300A/μs , T _J =25°C	---	80	---	nC

Note :

1. Repetitive Rating : Pulsed width limited by maximum junction temperature.
2. The data tested by pulsed , pulse width ≤ 300μs , duty cycle ≤ 2%.

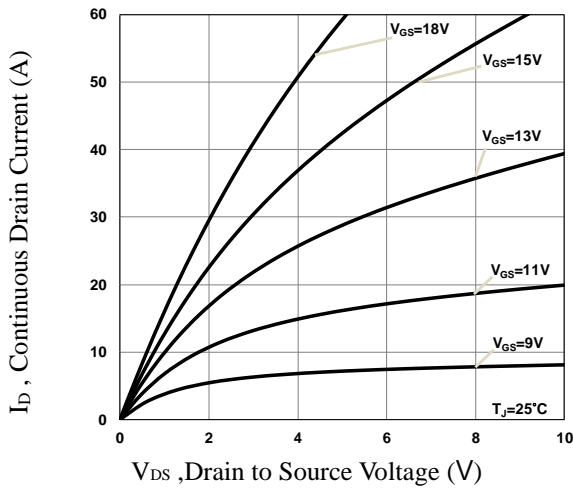

Fig.1 Typical Output Characteristics

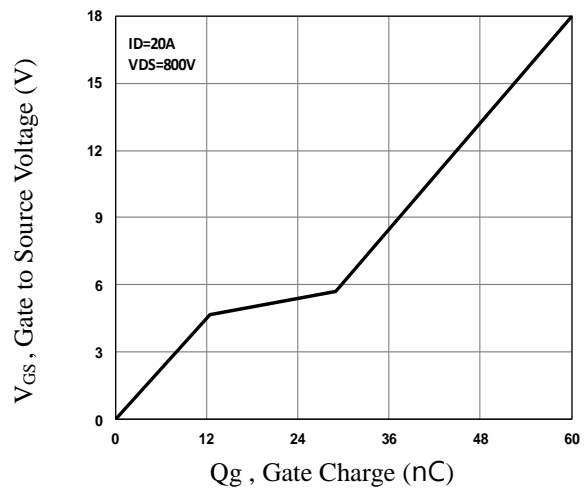

Fig.2 Gate Charge Characteristics

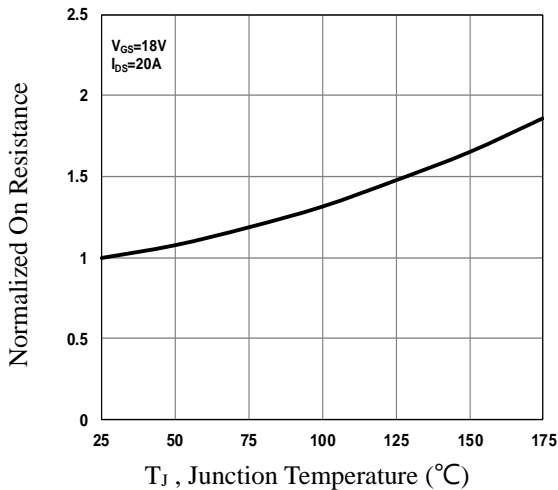

Fig.3 Normalized $R_{DS(on)}$ vs. T_J

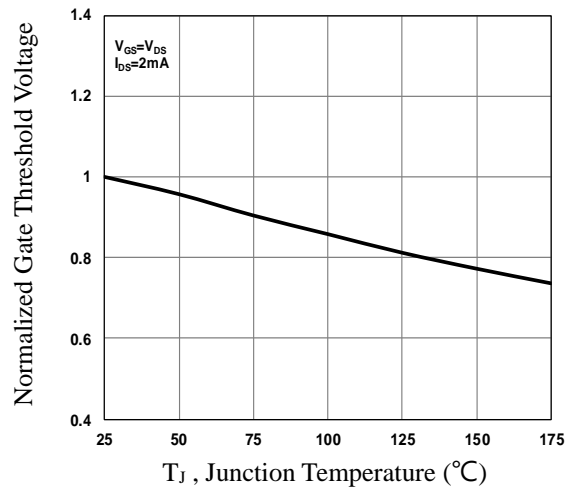

Fig.4 Normalized V_{th} vs. T_J

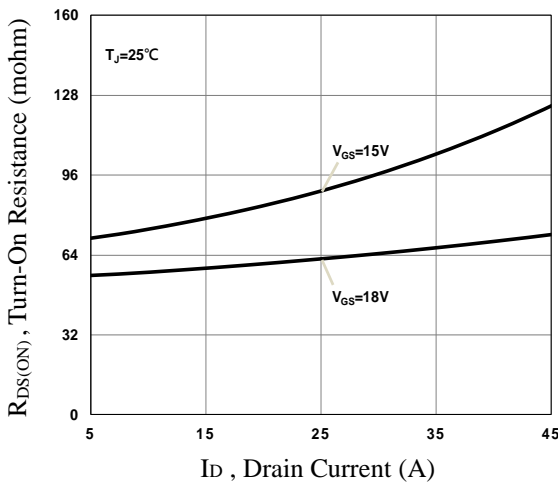

Fig.5 Turn-On Resistance vs. I_D

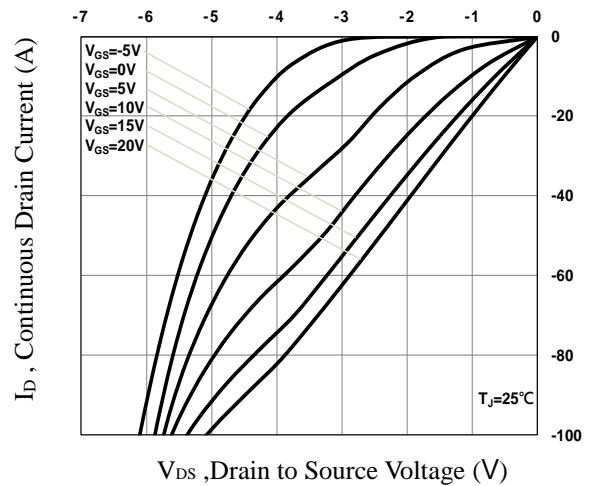

Fig.6 3rd Quadrant Characteristic

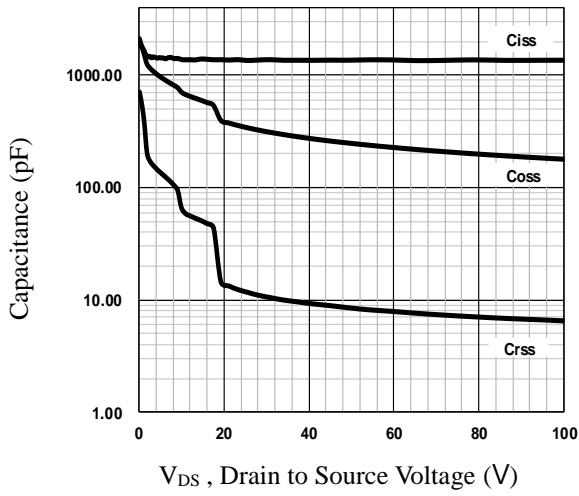

Fig.7 Capacitance Characteristics

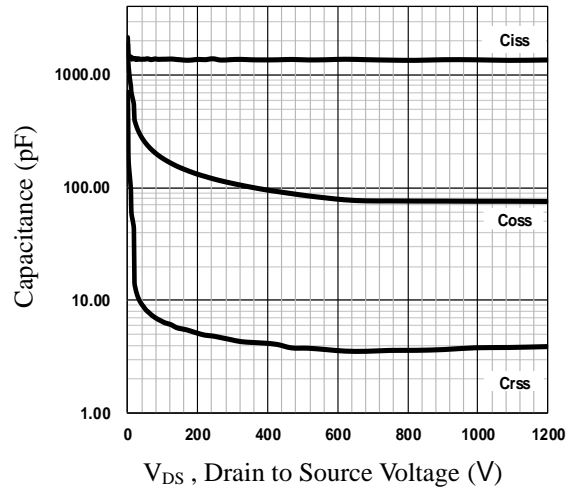

Fig.8 Capacitance Characteristics

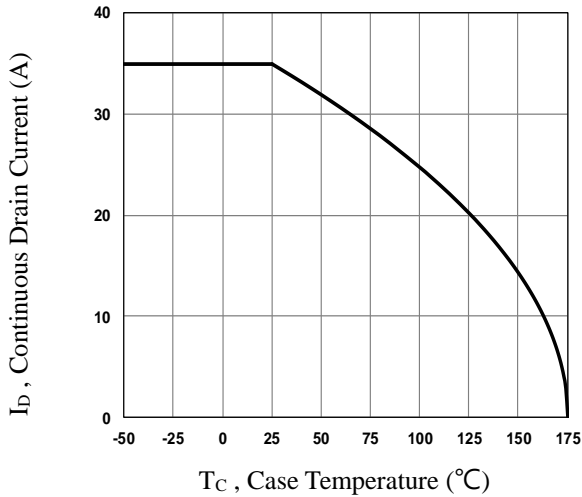

Fig.9 Continuous Drain Current vs. T_c

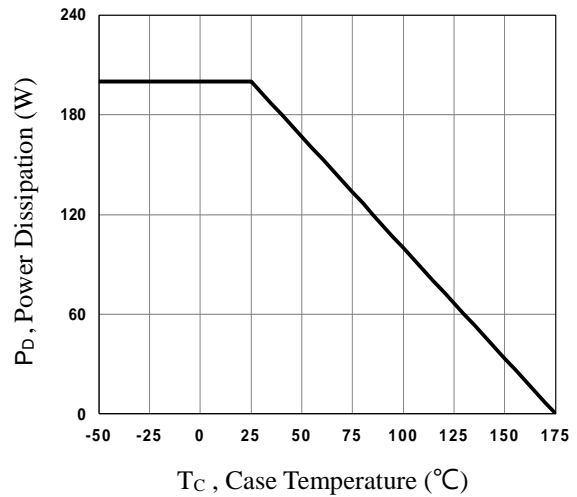
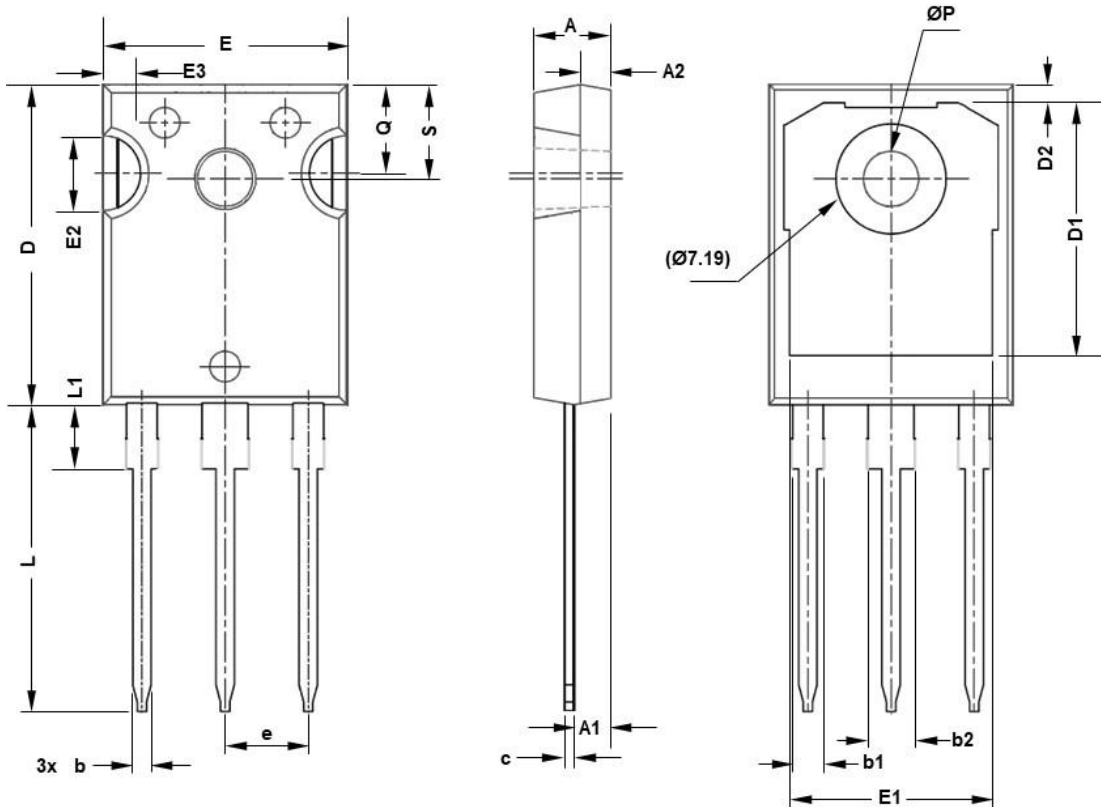

Fig.10 Power Dissipation Derating vs. T_c

TO247 PACKAGE INFORMATION



SYMBOL	mm		SYMBOL	mm	
	MIN	MAX		MIN	MAX
A	4.83	5.21	E2	4.32	5.49
A1	2.29	2.55	E3	2.15	2.80
A2	1.50	2.49	e	5.44BSC	
b	1.12	1.33	L	19.81	20.32
b1	1.91	2.39	L1	4.10	4.40
b2	2.87	3.22	ΦP	3.56	3.65
C	0.55	0.69	Q	5.39	6.20
D	20.80	21.10	S	6.04	6.30
D1	16.25	17.65			
D2	0.51	1.35			
E	15.75	16.13			
E1	13.46	14.16			